

# Flat Sheet Folder, Edition 2018

## Type **White Diamond** Automatic Sheet Set Folder

espriTech GmbH • Brunnenthalstrasse 16 • CH-3306 Etzelkofen • Switzerland

# espriTech

The **White Diamond** folding machine is for the folding and stacking of flat sheets, fitted sheets, duvet covers or other flat products - woven, nonwoven, non-elastic pieces.

This installation is prepared for manual feeding.

The folding machine is able to work up various material types including cotton, sateen, mixture fabric, polyester/cotton, and flannel.

The feeding edges of the pieces are shown as outside or as hidden inside fold.

The system is equipped with a cardboard inserting device for standard and book fold folding.

**Swiss Technology, made in Switzerland**

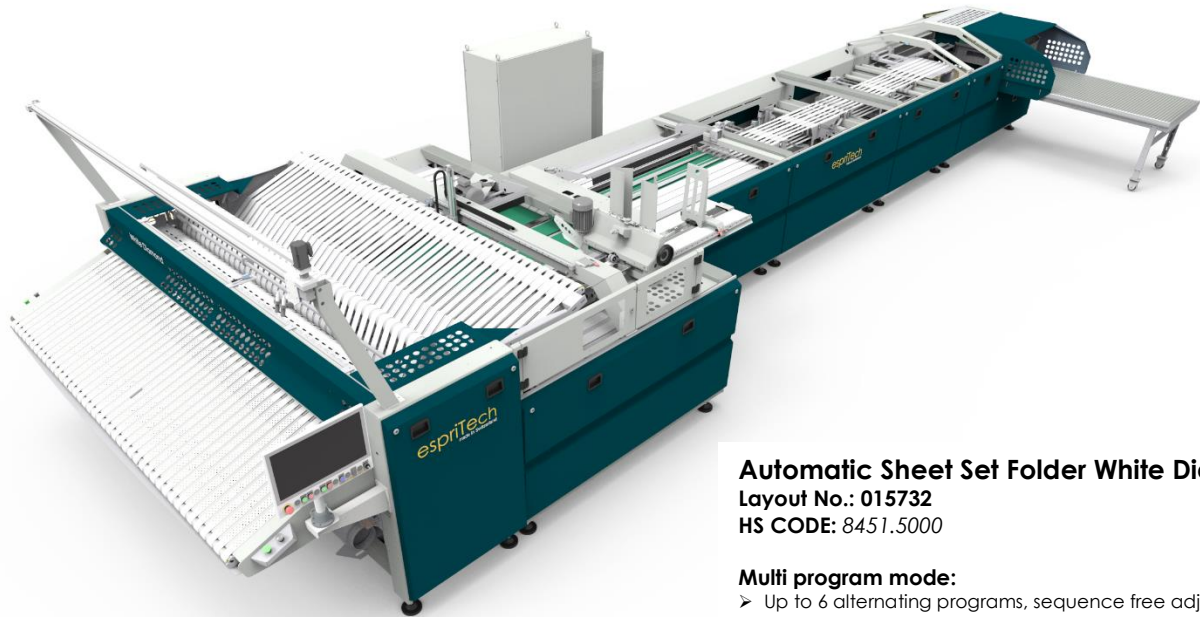

**Automatic Sheet Set Folder White Diamond**  
**Layout No.: 015732**  
**HS CODE: 8451.5000**

**Multi program mode:**

- Up to 6 alternating programs, sequence free adjustable and storable
- Up to 163 Sheet Sets/h, containing 1 Flat-, 1 Fitted Sheet and 2 Pillow cases
- Duvet Cover Set, Curtain pair, Table Linen Set
- Set cycle time depend on number of Items per Set

**Patent pending © espriTech**

**Feeding size:**

- (Additional Sizes on request)
- W = 40"-120"/1000 mm-3050 mm
  - L = 40"-130"/1000 mm-3300 mm

**Folding size:**

- (Additional sizes on request)
- A = 6"- 15"/152 mm-381 mm
  - B = 8"- 15"/228 mm-381 mm
  - C= gusset up to 6"/152 mm

**Folding pattern:**

- Top fold (visible boarder)
- Inside fold (hidden boarder)

**Production single program mode:**

- Two operator for manual feeding
- Up to 650 pieces/h

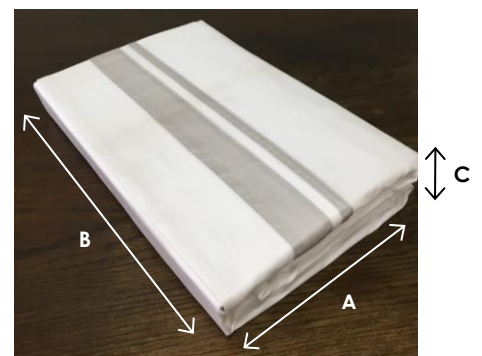

Book fold  
Boarder a cross

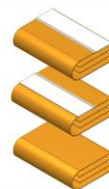

Standard fold  
Boarder a cross

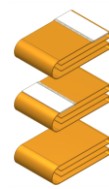

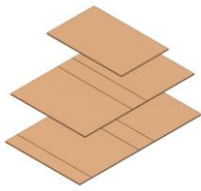

**Cardboard types & sizes (Standard & book cardboard for flat sheets):**

- (Additional sizes on request)
- Maximum width 381 mm (15")
  - Minimum width 152 mm (6")
  - Maximum length 698 mm (27 1/2") + height of the gusset max. 152 mm (6")
  - Minimum length 444 mm (17 1/2") + height of the gusset max. 152 mm (6")
  - Magazine load up to 405 mm (16")
- All cardboards will be folded to the very inside of the fabric, nonvisible

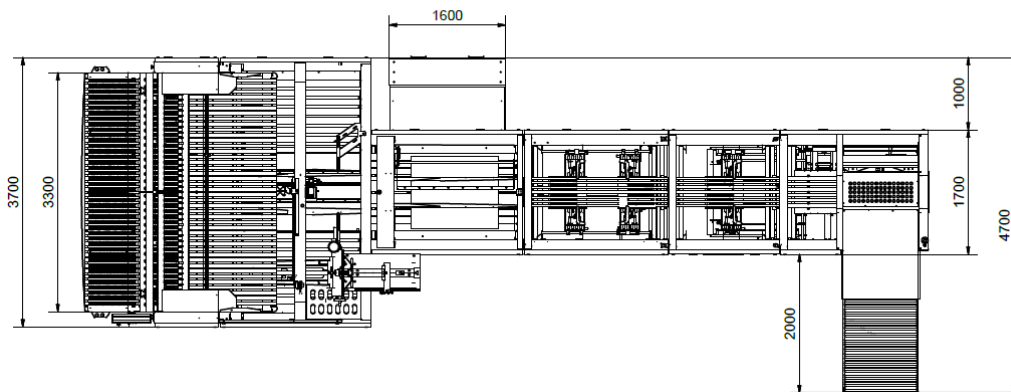
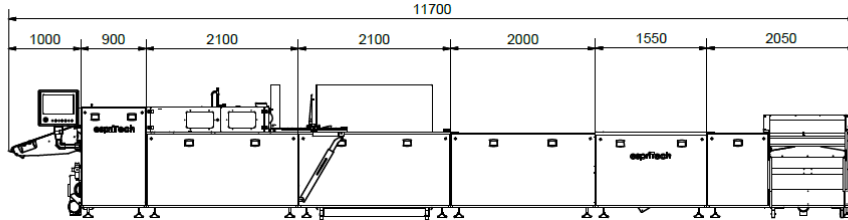

**Technic**

- 230/400 V 50/60 Hz, 3 phases /N/PE, approx. 20 A, 13 kW
- Compressed air 6 Bar/87 psi
- 800 l/min air consumption

**Control system:**

- Beckhoff TwinCat, PC- Windows 7
- 21" Touchscreen
- 40'000 program spaces
- Remote access integrated (Internet)
- Integrated cooling system

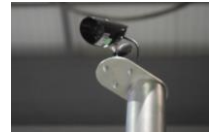
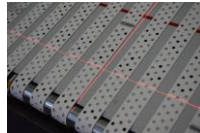

**Options**

- Automatic Laser, indicating automatically feeding position
- Motive centering device
- Camera System for Folding process observation
- Additional folding stations for 6" x 9" fold
- Online Stacking System
- Many other options on request

**Business contact:**

**espritech**

espritech GmbH  
 Brunenthalstrasse 16  
 CH-3306 Etzelkofen  
 Switzerland

[www.espritech.ch](http://www.espritech.ch)  
[info@espritech.ch](mailto:info@espritech.ch)

T: +41 32 530 22 78  
 F: +41 32 530 22 79

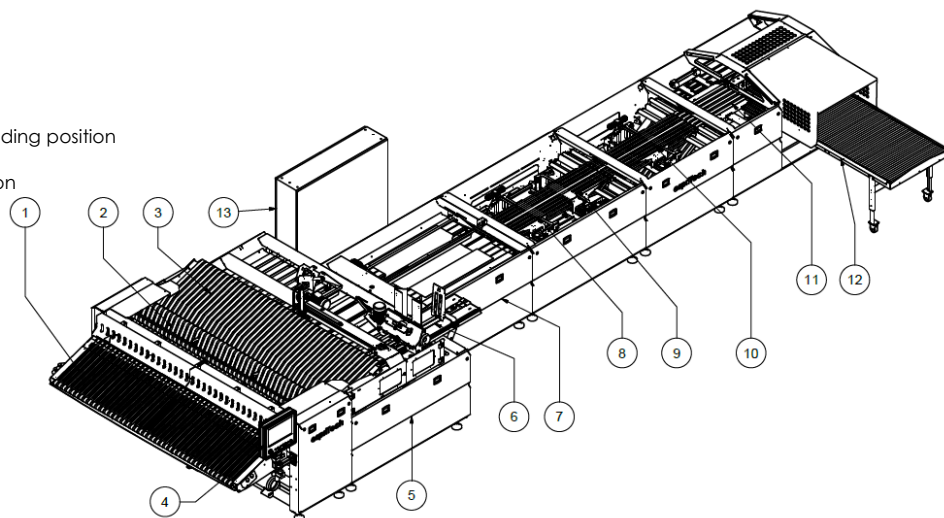

- |                                  |                            |
|----------------------------------|----------------------------|
| 1 Feeding station (option Laser) | 8 Cross fold C             |
| 2 Cross fold A                   | 9 Cross fold D             |
| 3 Cross fold B                   | 10 Cross fold E            |
| 4 Control panel                  | 11 Roll off stacker        |
| 5 Lateral folding station A      | 12 Roller conveyor         |
| 6 Cardboard inserter             | 13 Electro control cabinet |
| 7 Lateral folding station B      |                            |